

SHARP

MX-M550U/N

Digital Multifunction System



Fast-Tracking and Safeguarding All Your Document Needs

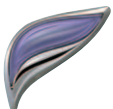

..... **be sharp**

- COPY
- NETWORK PRINT
OPTION for U Model
- NETWORK SCAN
OPTION
- SHARPEDESK
OPTION
- FAX
OPTION

Providing Secure Solutions to High-Speed, High-Volume Demands

The Sharp MX-M550U/N is the key to faster, more efficient, and more secure document management for the performance-driven office. The heavy-duty design of this multifunctional powerhouse, packed with productivity-boosting features, ensures reliable high-speed, high-volume output. Its network scanning powers and integrated document management capabilities let you distribute information where and when you need to. And, enhanced security features on the MX-M550U/N safeguard your office communications without hindering workflow.



MX-M550U/N

Digital Multifunctional System

Designed with Simplicity and the Environment in Mind

The MX-M550U/N is easy for everyone in your office to use, regardless of ability or experience. A large, easy-to-follow, 8.9-inch touch-screen LCD enables you to navigate smoothly through the machine's advanced functions.

The MX-M550U/N has been recognised by the Energy Star programme, an international system for identifying energy-efficient products. It also complies with the RoHS Directive restricting the use of hazardous substances.

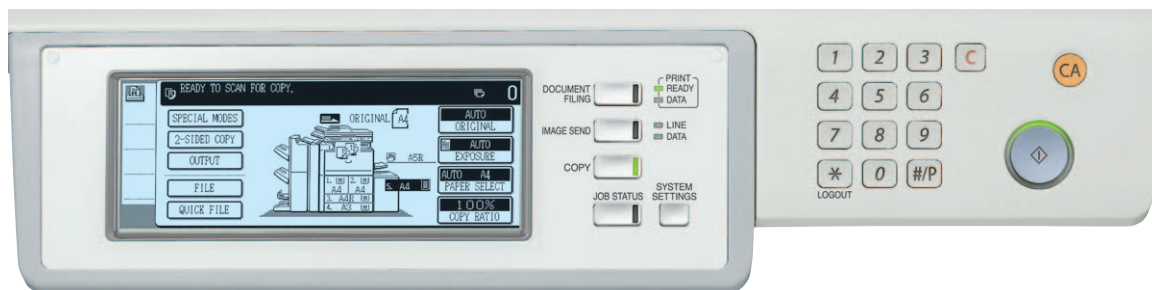

COPYING AND PRINTING	NETWORK SCANNING	DOCUMENT FILING	FAXING	SECURITY	RELIABILITY AND USABILITY	OPTIONS	SPECIFICATIONS
P. 3-4	P. 5	P. 6	P. 7	P. 8	P. 9	P. 10	back cover



Key Features

Exceptional Productivity

- Speedy output of max. 55 ppm and quick first copy time
- Standard stackless duplex module and 150-sheet Duplex Single Pass Feeder
- Professional job finishing options include booklet making and post-sheet insertion
- Network tandem function*1 doubles output speed by linking two machines
- Large paper capacity of max. 6,600 sheets
- Job Build for large-volume documents

High Image Quality

- Enhanced 1,200 x 600-dpi resolution and 256-level greyscale
- Digital auto exposure control and Text/Photo mode
- Feedback process control monitors toner density to maintain print quality

All-in-One Performance

- Powerful network printing*1
- PCL5e/PCL6 and optional PS3 emulation
- Optional network scanning with scan to e-mail/FTP server/HDD/desktop/network folder (SMB)
- Sharpdesk for easy, integrated document management on a PC
- Document filing function to instantly reuse saved jobs on the HDD
- Optional Super G3 fax and Internet fax
- LDAP support for easy browsing of e-mail addresses and fax numbers



Versatile Operation

- 8.9-inch touch-screen LCD control panel
- Supports the latest operating systems and network protocols, including IPv6
- Sharp OSA (Open Systems Architecture)*2 allows integration with software programmes and makes them accessible from the LCD control panel
- Advanced device management with Sharp network utilities*1

Multi-Layered Security

- Secure network interface card restricts unauthorised access*1
- Optional Data Security Kit encrypts and erases confidential data
- SSL (secure sockets layer) and IPsec*3 for secure network communications
- Confidential Print secures printing with PIN code authentication
- User authentication for network scanning

Reliable, Heavy-Duty Design

- Highly rigid frame for higher durability
- Stable paper feed with full-grip short paper path
- Lead and chromium-free design (RoHS compliant)
- Job Status screen lets you view the list of jobs in progress

*1: MX-M550U requires optional MX-NBX1

*2: Requires optional MX-AMX2 and/or MX-AMX3

*3: Available at a later date

COPYING AND PRINTING

Quick First Copy Time

The MX-M550U/N has a quick first copy time of **4.0 seconds** to save valuable time when performing multiple short-run jobs.



Exceptional Output Speed

With a continuous output of **55 cpm/ppm***, the MX-M550U/N allows you to produce large-volume documents that include memory-intensive graphics in less time.



* A4 (8 1/2" x 11") size, portrait

Duplex Single Pass Feeder (DSPF)

The MX-M550U/N comes standard with a highly efficient **150-sheet DSPF** (duplex single pass feeder), which **scans both pages** of two-sided documents **up to A3** (11" x 17") in size in one pass. Doing away with the reversing circuit minimises paper misfeeds and vastly improves reliability. With a scanning speed of **76 originals per minute** (opm) for duplex mode and 65 opm for simplex mode, the MX-M550U/N finishes even large projects quickly.



Job Build for Large-Volume Scanning

The MX-M550U/N easily handles copy jobs exceeding the DSPF's 150-sheet capacity*1. Large-volume documents of up to 10,000 pages*2 are automatically stored in the MX-M550U/N's hard disk. Users can then print the entire document in a single run.

*1: A4 (8 1/2" x 11") size

*2: Measured using Sharp's standard chart (A4 with 6% coverage). The number of pages that can be stored for the Job Build function depends on the machine's HDD capacity and other conditions.

Automated Job Finishing

The MX-M550U/N makes it easy to create professional-looking booklets. Working together with the highly productive built-in stackless duplex module, the optional **Saddle Stitch Finisher** folds and staples sets of documents to make completed booklets. The **Inserter** adds pre-printed covers or inserts up to 256 g/m² to your documents for truly professional results. And, a **Punch Module** allows you to punch holes in documents for easy filing. These high-performance finishing capabilities save you valuable time and money by reducing costly outsourcing.



Highly Productive Output

The MX-M550U/N's Scan Once/Print Many function requires only a single scan of a multi-page original for copying, while its RIP Once/Print Many function needs only a single download of the print data from the PC for printing. The MX-M550U/N then automatically outputs **collated** sets of copies or printouts in the proper page order. Each set is **stacked offset*** for easier retrieval and up to **999 copies** can be made directly from memory. This highly productive process allows you to easily handle high-volume jobs.

* Requires optional finisher or saddle stitch finisher

Built-in Stackless Duplex Module

The MX-M550U/N can make **two-sided copies and printouts** using its built-in stackless duplex module, effectively reducing paper costs as well as saving filing space. Auto duplexing is available for paper weights up to **205 g/m²**. Duplex copying is even more productive when used together with the 150-sheet DSPF.

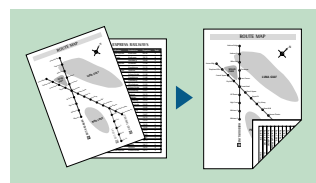

Large Paper Capacity

The MX-M550U/N comes standard with **3,100-sheet** paper capacity: two 500-sheet drawers, an 800-sheet drawer, a 1,200-sheet drawer, and a 100-sheet multi-bypass feeder.

For large-volume jobs, the MX-M550U/N can accommodate up to **6,600 sheets** when equipped with the optional 3,500-sheet large-capacity tray. When a tray runs out of paper, the **Auto Tray Switching** function automatically switches to another paper tray filled with the same size paper. This allows you to do extra-large volume jobs without worrying about running out of paper.



Network Tandem Function

When two MX-M550U/Ns are connected to the same office network, you can use both simultaneously to double output up to **110 cpm/ppm**. Operation is simple and the machines can even be in different locations. With just a few keystrokes, you can handle large-volume jobs to meet tight deadlines.

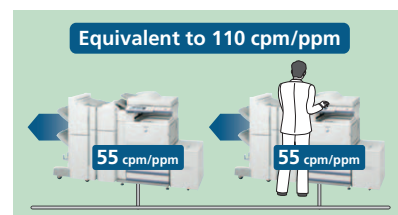

Note: Network print function is standard on the MX-M550N but the MX-M550U requires the optional MX-NBX1 Network Expansion Kit.



Professional Job Finishing

Multi-page document (copy or print)



Booklet making

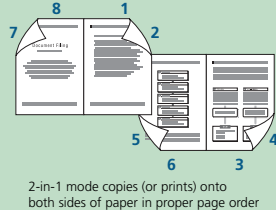

Inserter (option)



Inserts pre-printed cover sheet

Saddle Stitch Finisher (option)

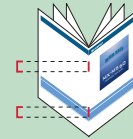

Staples and folds pages



Ready to use!

PCL6 and PostScript 3 Emulation

PRINT

The MX-M550U/N supports **PCL5e** and **PCL6** printer languages. For compatibility with **PostScript 3**, the MX-PKX1 PS3 Expansion Kit is available.

Powerful Network Printing

PRINT

The MX-M550U/N works as a network printer* with the latest and most commonly used network operating systems and protocols, including IPv6, and even in mixed network OS environments. With a 64-bit, 600-MHz CPU, you get powerful network printing via 100Base-TX and 10Base-T Ethernet standards.

* MX-M550U requires optional MX-NBX1

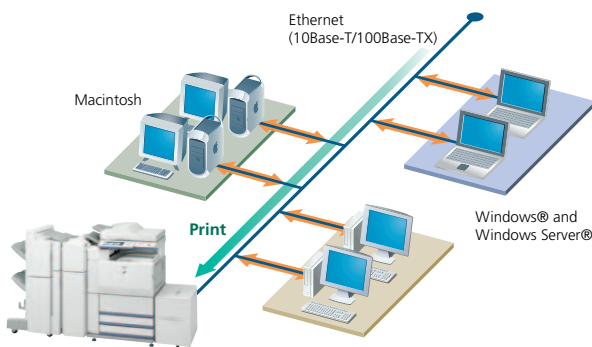

Various Copy/Print Applications

COPY
PRINT

COPY & PRINT

- **Tab Copy/Print** can copy or print directly onto tabs on document separators and insert them into assigned positions, enabling you to create professional-looking documents.



PRINT

- With **PDF/TIFF Direct Print**, you save valuable time by printing PDF and TIFF files without using the printer driver or opening applications: you can print the file directly from an FTP server (pull print), a Web page (push print), or an e-mail attachment. Note: Direct PDF printing requires optional MX-PKX1; please consult your sales representative for further details.
- **Carbon Copy Print** mode automatically outputs multiple printouts of the same data on plain and/or coloured paper from different paper trays; convenient for invoices and purchase orders.
- **Proof Printing** allows you to check a trial set before printing out a document in large numbers in order to avoid printing mistakes.
- **Barcode font** compatibility (requires optional AR-PF1 Barcode Font Kit)

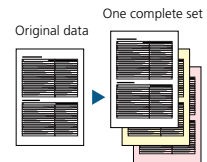

Space-Saving Inner Output Tray

COPY
PRINT

The inner output tray gives the MX-M550U/N a compact design. Installing the optional finisher allows convenient separate output of copies and printouts.

High Image Quality

COPY
PRINT

You get ultra-detailed reproduction with 600 x 600-dpi resolution. The printing resolution can be enhanced to 1,200 dpi (with smoothing). Digital Auto Exposure Control provides optimum copy contrast, and Text/Photo mode automatically adjusts the copy contrast for documents containing both text and photos.

COPY

- **Book Copy** is convenient for compiling copies of a book or bound originals into pamphlet format.
- **Card Shot** enables one-touch copying of both sides of a card (credit cards, ID cards, etc.) onto a single page.

Book Copy

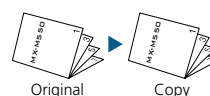

Card Shot



NETWORK SCANNING



Speedy A3 Network Scanning

The 150-sheet DSPF and optional MX-NSX1 Network Scanner Expansion Kit turn the MX-M550U/N into an ultra-efficient **network scanner*** that can be used with any Windows PC on the network. Converting any type of paper-based document, up to A3 (11" x 17") in size, into an editable digital file is as easy as making a copy. The 150-sheet DSPF lets you quickly scan two-sided originals at up to 64 pages per minute.

* MX-M550U requires optional MX-NBX1

Multiple Distribution of Scanned Files

With the touch of a few buttons, you can choose different ways to distribute your scanned documents. **Scan to E-mail** allows you to send documents as an attachment to any e-mail address over the Internet. **Scan to FTP Server** lets you scan a document directly to an FTP server for special applications such as company-wide posting or archiving. **Scan to Desktop** enables you to send scanned documents directly to your PC desktop. With Sharpdesk, Sharp's powerful but easy-to-use document management software, editing and managing scanned documents is easier than ever. **Scan to HDD** sends scanned images to the MX-M550U/N's built-in hard disk to use in the Document Filing function. **Scan to Network Folder (SMB)** sends files to a shared folder on a networked Windows PC. And **Scan to Fax** enables conventional faxing or Internet faxing.

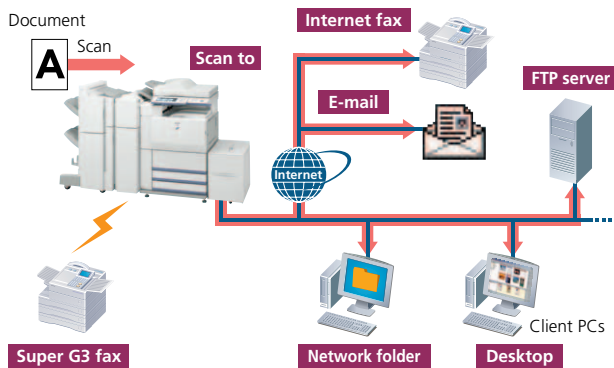

LDAP Support

Built-in LDAP (lightweight directory access protocol) support eliminates the need to enter or register full addresses. Simply enter the first few letters of the recipient's name and the MX-M550U/N displays a list of possible matches on your company's LDAP server. This feature saves precious time and lets you avoid errors when typing e-mail addresses. After searching, selected addresses can be stored to the MX-M550U/N's address book. And the integrated **User Authentication** function (see page 8) blocks unauthorised access by requiring the user to log in before searching for an address.

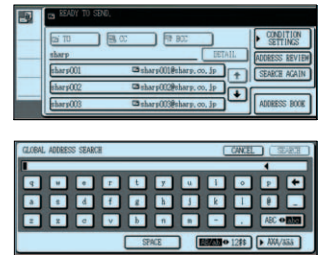

Easy Text Entry

Use the LCD control panel's onscreen keyboard to customise file names or e-mail messages and subject titles, making it easier for the recipient to recognise and archive this information.

TWAIN Support

With support for the TWAIN standard, the MX-M550U/N allows you to use scanned images with any commercially available TWAIN-compliant application (push out method).

Linearised PDF **NEW**

With the MX-M550U/N, you can create linearised PDF files, which allow the first page of a PDF file to be displayed in a user's Web browser before the entire file is downloaded. This saves users the time and frustration of having to wait for large PDF files to be displayed in their Web browsers.

Sharpdesk for Total Document Management

Sharpdesk is an original Sharp application that provides integrated desktop management of documents in over **200 file formats**, including scanned paper-based documents and those created with popular applications such as Word. It allows you to organise, edit, search and distribute your documents, all with simple drag-and-drop operation.

- Intuitive desktop display features **thumbnail** viewing
- Sharpdesk Imaging provides **annotation** tools for paper-free proofreading
- Sharpdesk **Composer** combines different types of files into a single document
- **Optical character recognition** converts documents into editable text files
- **Output zone** distributes files to e-mail, printers and other applications
- **File search** allows searching by file name, keyword or thumbnail

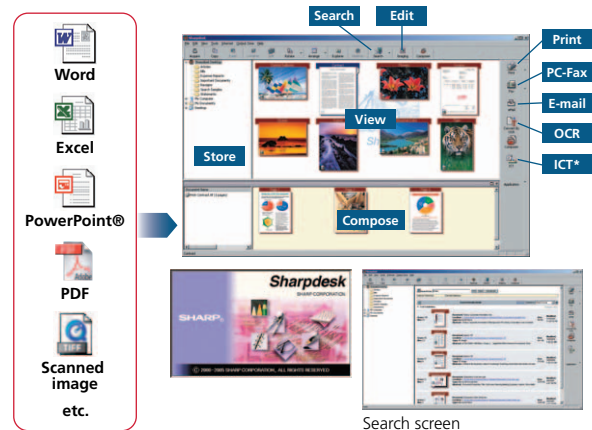

* Image Compression Tool for converting images into high-compression PDF files.

DOCUMENT FILING

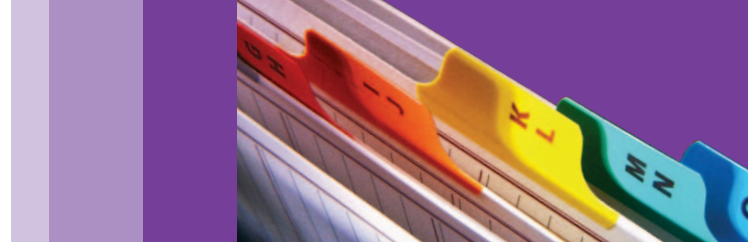

Document Management on the Hard Disk

You can save processed job data in designated folders on the MX-M550U/N's built-in hard disk, making it easy to instantly recall saved documents or jobs for printing and sending at a later time. This contributes greatly to efficient sharing and distribution of information in your business operations.

Easy Access to Stored Files

Documents that are stored on the hard disk can be quickly searched and accessed from the control panel display or through a Web browser.

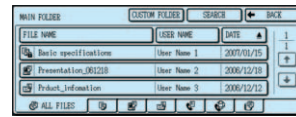

Document Filing screen (Main Folder)



Web access screen

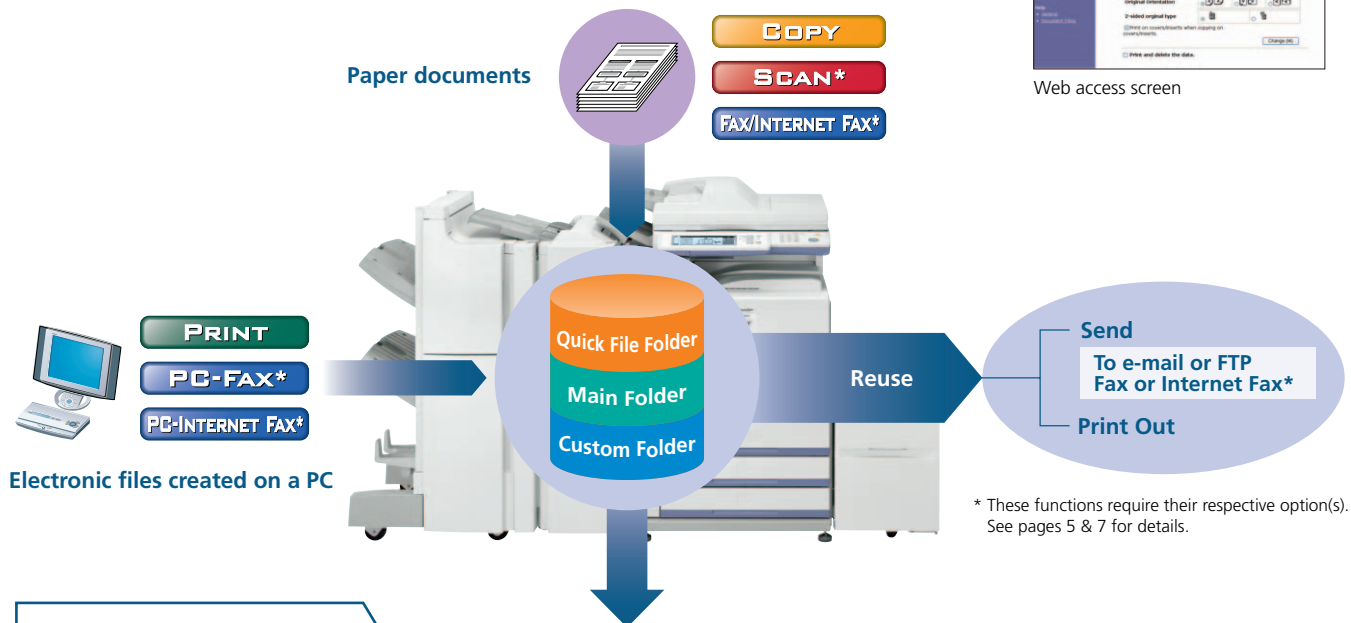

* These functions require their respective option(s). See pages 5 & 7 for details.

Quick Filing

Up to **10,000 pages** or 1,000 files*¹ that have been copied, printed, scanned or faxed*² can be stored by job on the hard disk in a Quick File Folder. You can reuse saved data with simple operation without having to reload or rescan the original.

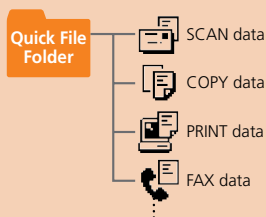

Advanced Filing Function

Up to **20,000 pages** or 3,000 files*¹ that have been copied, printed, scanned or faxed*² can be stored by job on the hard disk in up to 500 folders with customised names and locations. Enhanced security features require users to enter a 5 to 8-digit password to access secure folders, protecting your sensitive data. Storage options include:

- **Main Folder** – You can store processed files by user name in the main public folder and share them across the workgroup. Any file name and a PIN code can be assigned to each saved job.
- **Custom Folder** – Up to 500 private folders (named as desired) can be created within the Custom Folder. When saving a file in a private folder, any file name can be assigned. A PIN code can be applied to both private folders and files.

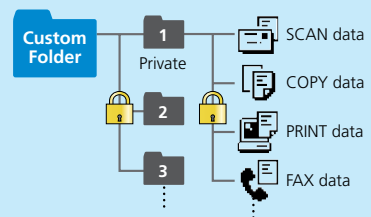
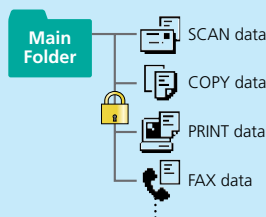

*1: Measured using Sharp's standard chart (A4 with 6% coverage). The Quick File Folder shares the HDD with the Job Build function.

*2: For fax and Internet fax jobs, only transmitted data (not received faxes) can be saved in the Document Filing function.

FAXING



High-Speed Faxing

The optional AR-FX8 Fax Expansion Kit turns the MX-M550U/N into a 33.6 Kbps **Super G3 fax**. Using JBIG compression technology, the MX-M550U/N can send an A4 (8 1/2" x 11") size page in under 3 seconds*. Use the 150-sheet DSPF to further boost faxing efficiency. And because Quick On-Line Transmission can start dialling and transmitting as soon as the first page is scanned into memory, you can send documents in **much less time**.

* Based on Sharp's standard chart with approximately 700 characters (A4 or 8 1/2" x 11" portrait) at standard resolution

Paperless Faxing with Inbound Routing **NEW**

The MX-M550U/N can be set to forward incoming fax data to a designated e-mail address. You can then check those incoming faxes on a PC and print only what you need—a great way to save paper.



PC-Fax/PC-Internet Fax

A PC-Fax/PC-Internet Fax function allows you to directly send a document created on your PC to a recipient's fax machine via a phone line or the Internet. Since all faxing procedures are done on your PC without printing to paper, this function saves time and costs, increases faxing productivity, and retains original document quality.

Note: PC-fax requires optional AR-FX8 and PC-Internet Fax requires optional MX-FWX1



Send and Receive Faxes Over the Internet

You can send faxes to other ITU-T T-37-compliant Internet fax machines via the Internet without worrying about costs. Plus, you don't need to wait around for transmission since the documents are scanned into and then sent from memory. It's also much faster than public phone lines.

Note: Requires optional MX-FWX1

Duplex Transmission and Reception

With the DSPF, the MX-M550U/N scans both pages of two-sided documents and sorts them in memory. The pages are then transmitted in the proper order. Thanks to the standard duplex module, the MX-M550U/N can also print incoming faxes onto both sides of paper, thus saving you paper costs.

999-Number Auto Dialling

Register up to 999 frequently used numbers into the customisable directory of one-touch auto-dial keys, listed in alphabetical order for easy searches of specific numbers.



Multi Access Function

You get two different functions simultaneously; for example, you can scan documents into memory for transmission while you receive an incoming fax.

Flash Memory Backup

In case of power failure, documents stored in memory are retained until power is restored, preventing data from being lost.

Super Fine Mode

You can set the MX-M550U/N to this ultra-high resolution to give the recipient crisp, clear reproduction of detailed images and fine text.

Other Key Features

- **Long originals** (up to 800 mm long) can be sent using the DSPF
- **Broadcast transmission** up to 5,000 destinations via direct address entry (500 destinations when using one-touch auto-dial keys)
- **Programme keys** (up to 8 keys) are available to set up frequently used transmissions for instant recall
- **Mixed size original scanning** automatically distinguishes documents of mixed sizes fed through the DSPF
- Convenient **image editing** functions: Edge/Centre Erase, 2-in-1, Card Shot
- **F-Code communication** enables confidential communication, relay request transmission, and memory polling with fax machines from other brands that conform to the ITU-T F-Code (sub-address and pass code) standard
- **Automatic transmission reduction** automatically reduces the size of the document being sent to fit the paper size of the recipient machine
- **Memory transmission/reception** stores documents in memory, allowing the originals to be returned to the user quickly and saving incoming faxes in memory if the MX-M550U/N runs out of paper or toner
- **Timer transmission** enables unattended after-hours operation when reduced phone rates are in effect
- **Polling** allows the user to retrieve a document left in the feeder of a remote fax machine
- **Print actual size** prints out long-length faxes onto separate sheets of paper
- **Rotation reception/transmission** rotates incoming or outgoing faxes to match the direction of the printing paper

Note: The AR-FX8 may not be available in some regions.

SECURITY



Industry-Leading Multi-Layered Security

With multiple levels of network and data security to cover a wide range of security needs, Sharp's industry-leading security solutions bring today's businesses increased confidence and peace of mind. The MX-M550U/N safeguards sensitive data with powerful, enhanced security functions that eliminate the worry of unauthorised use and guarantee greater protection for your confidential information.

Data Security Kit

Digital copier/printers or multifunction products can retain hundreds of pages of confidential information from previous jobs on their hard disks or internal memory. To safeguard this information from unauthorised access, the optional **Data Security Kit** automatically **encrypts and erases** the data after each job is complete as well as data stored both on the hard disk and in the address book.

IP/MAC Address Filtering

The MX-M550U/N's network interface card* provides highly secure operation by restricting access to the MX-M550U/N on your office network. Only PCs that have either their **IP address** or **MAC (media access control) address** registered are allowed to use the MX-M550U/N. Attempted access from an unknown IP or MAC address will be denied, preventing unauthorised use.

* MX-M550U requires optional MX-NBX1

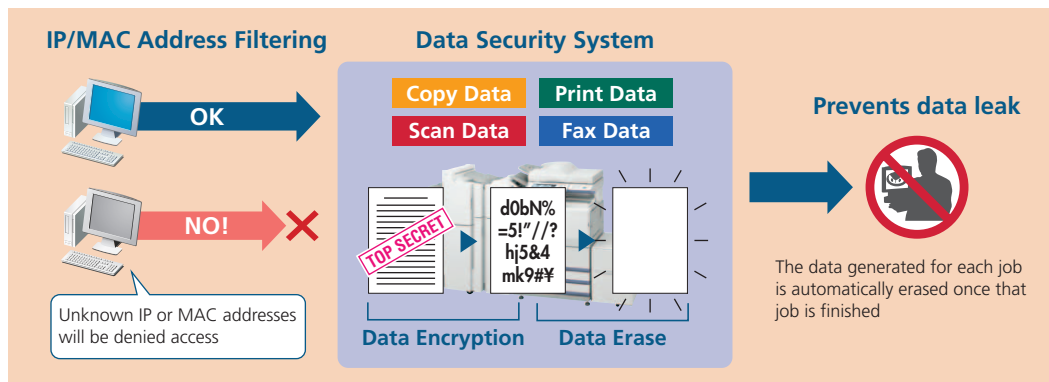

Print Hold and Confidential Print

To keep others from seeing confidential documents as they are being printed out, the MX-M550U/N's **Print Hold** function stores print data on its hard disk and withholds output until the user executes a print command from the control panel. For added security, the **Confidential Print** function requires the user to enter in a PIN (personal identification number) at the machine before printing can begin.



Auditing Mode

Auditing modes can be set individually for each function (copy, print, scan, fax, document filing), so you can keep track of and control the amount of use by employee or department. Limitations can be set for each account and each function.

User Authentication for Network Scanning

To prevent unauthorised use of network scanning, the MX-M550U/N supports user authentication, which requires users to log in to the machine before performing any network scanning operations. Four types of user authentication methods are provided (Simple, Digest-MD5, NTLM, and Kerberos).



Secure Sockets Layer **NEW**

A newly introduced SSL (secure sockets layer) enables the encryption of data communications to prevent data leakage through the network when printing via IPP, browsing secure Web pages (HTTPS) or communicating via e-mail (SMTP* and POP3*) or FTP (FTPS*).

* Available at a later date

IPv6 and IPsec Support **NEW**

The MX-M550U/N supports IPv6, the next-generation Internet protocol. An obligatory part of IPv6 is IPsec* (IP Security), a set of protocols for securing Internet protocol (IP) communications. IPsec encrypts and authenticates traffic between specified parties, giving IPsec-compatible products an extremely high level of network security.

* Available at a later date

RELIABILITY AND USABILITY



Build Solid

Highly Rigid Frame

The MX-M550U/N utilises a high-rigidity frame to ensure ample robustness to withstand heavy use from high-speed or high-volume output. Stability has been improved by keeping mechanical stress and distortion as low as possible.

Full-Open Paper Path

A door on the left side of the unit provides complete access to the vertical paper transfer path. In the unlikely event of a paper jam, this convenient design allows the jam to be cleared simply and easily, with reduced downtime as a result.



Feedback Process Control

This unique system periodically monitors actual toner density and automatically makes adjustments to maintain image quality over a long period of time.

Full-Grip Short-Path Design

To enhance reliability in the paper transfer process, the MX-M550U/N adopts a full-grip short-path design. The rollers, which can handle a wide range of paper from 60 to 205 g/m², continually grip the paper, providing consistent, reliable paper transfer.

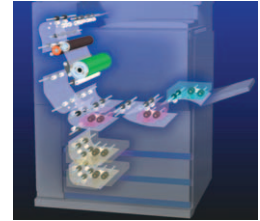

External Heat Rollers

A Sharp proprietary external heat roller system keeps roller temperature uniform. This provides stable, consistent fusing and prevents slowing down of the machine, thus further raising reliability of the MX-M550U/N.

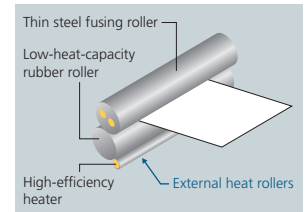

User-Friendly

8.9-Inch LCD Panel NEW

The MX-M550U/N's logically designed control panel features a wide, clear **touch-screen LCD** with easy-to-follow guidance. For example, when adjusting the edge/centre erase function or, in the event of a paper jam, the LCD displays step-by-step instructions to guide you through the necessary procedures.

Easy Printer Control

The printer driver gives you clear and easy control of print jobs thanks to a simple, easy-to-understand GUI (graphical user interface). Simply click the appropriate icons or check boxes and print your document just the way you want it.

Advanced Device Management

- Administrators can set up many features from either over the network or from the control panel of the MX-M550U/N, including address book control, document filing management and user control (accounting).
- Printer Administration Utility** makes printer networks easier to manage by allowing network administrators to customise monitored items and view settings such as the IP address directly from their PC through a standard Web browser.
- If the MX-M550U/N is low on paper or toner, the **Printer Status Monitor** will alert you in the form of easy-to-understand graphics, allowing you to avoid problems before they arise.

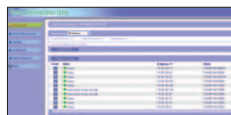

Web-based PAU 4.0

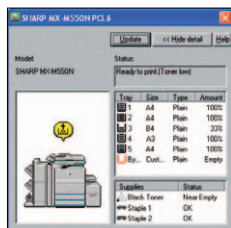

Printer Status Monitor

Job Status Screen

Whether printing or copying, the LCD displays a list of all jobs, showing you at a glance the jobs in progress and the position of your job in the queue.

Environmentally Conscious Design

- Recognised by the **Energy Star** programme, an international standard for energy-efficient products.
- In **support of the RoHS directive**, which restricts the use of hazardous substances, Sharp has fully eliminated harmful lead and chromium in all MX-M550U/N parts and materials.

Device Cloning

Machine settings can be copied conveniently to another MX-M550U/N via a Web browser, making it easy to clone machines in a networked environment.

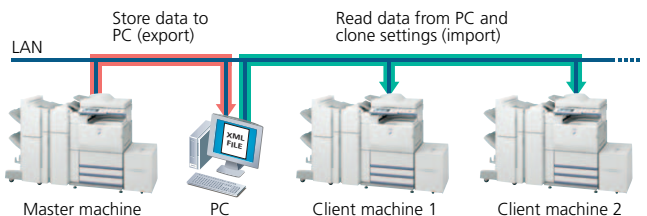

Sharp OSA (Open Systems Architecture) NEW

The MX-M550U/N has an open system architecture that allows third-party software developers to create custom applications* that link the MFP to software programmes on a server or PC. The LCD control panel can thus be used to access and operate these software programmes.

* Requires optional MX-AMX2 and/or MX-AMX3

OPTIONS



System Configuration

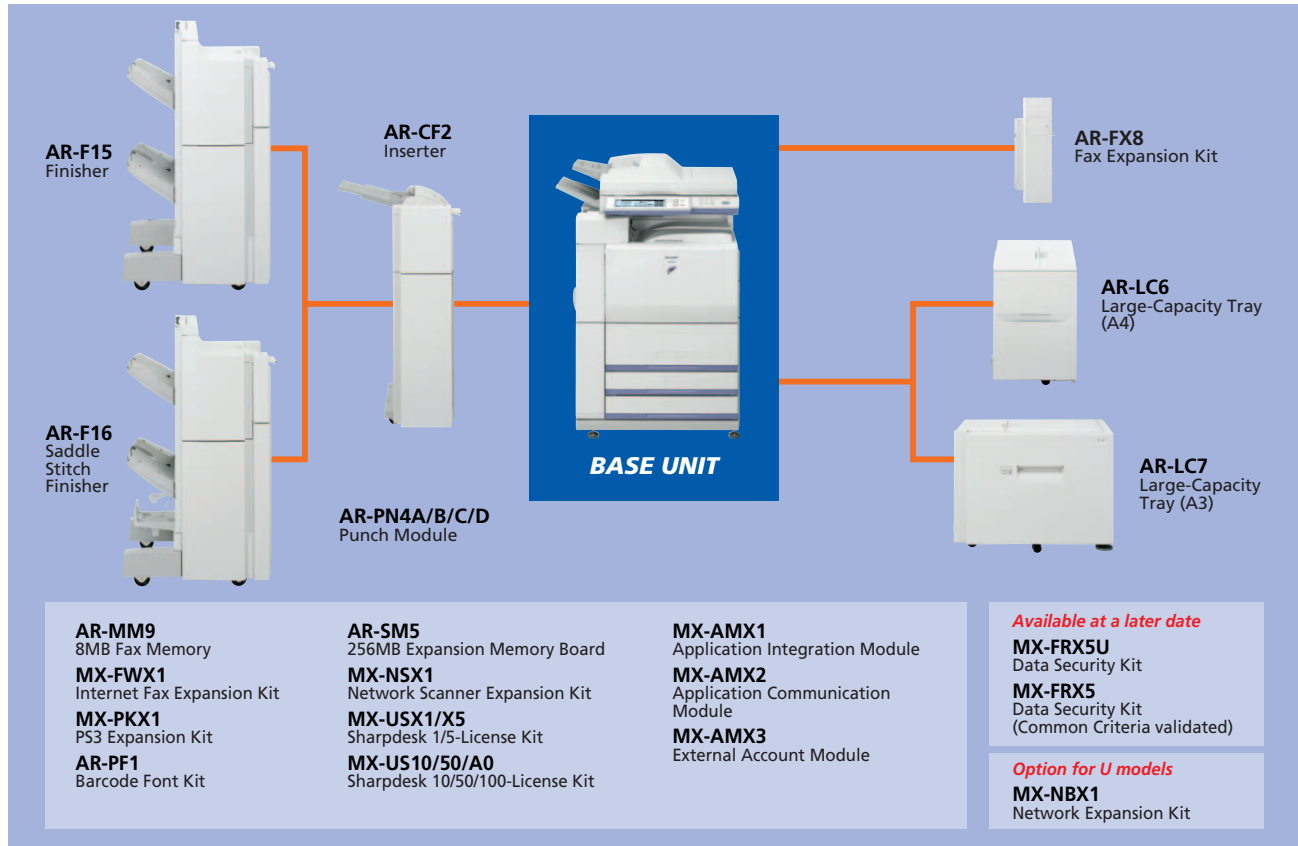

Note: AR-CF2 requires AR-F15 or AR-F16.
Some options may not be available in some areas.

Specifications for Options

AR-F15 Finisher

Paper size	Non offset	A3 to A5R (11" x 17" to 5 1/2" x 8 1/2R")
	Offset/staple	A3 to B5 (11" x 17" to 8 1/2" x 11R")
Max. paper capacity (80 g/m ²)		2,000 sheets (A4, 8 1/2" x 11")
Max. stapling capacity (80 g/m ²)		50 sheets (A4, 8 1/2" x 11")
Staple position		3 locations (front, rear or both)

AR-F16 Saddle Stitch Finisher

Paper size	Non offset	A3 to A5R (11" x 17" to 5 1/2" x 8 1/2R")
	Offset/staple	A3 to B5 (11" x 17" to 8 1/2" x 11R")
Max. paper capacity (80 g/m ²)		2,000 sheets (A4, 8 1/2" x 11")
	Saddle stitch tray	10 sets (11–15 sheets), 20 sets (6–10 sheets), 25 sets (1–5 sheets)
Max. stapling capacity (80 g/m ²)		50 sheets (A4, 8 1/2" x 11")
Staple position		3 locations (front, rear or both)

Punch Modules

Model name	AR-PN4A	AR-PN4B	AR-PN4C	AR-PN4D
Number of holes	2	2 or 3	4	4 (wide)
Paper weight	60 to 256 g/m ²			

AR-CF2 Inserter

Paper size	A3 to A5R (11" x 17" to 5 1/2" x 8 1/2R")
Paper weight	60 to 256 g/m ²
Paper capacity (80 g/m ²)	100 sheets

AR-LC6 Large-Capacity Tray

Paper size	A4 (8 1/2" x 11")
Paper capacity (80 g/m ²)	3,500 sheets

AR-LC7 Large-Capacity Tray

Paper size	A3 (11" x 17")
Paper capacity (80 g/m ²)	3,000 sheets

AR-FX8 Fax Expansion Kit

Compression method	MH/MR/MMR/JBIG
Communication protocol	Super G3/G3
Modem speed	33,600 bps to 2,400 bps

Sharpdesk 3.2 System Requirements

CPU	Pentium 500MHz processor or better (750MHz or better for Windows® XP)
Memory	256MB or more (512MB or more recommended)
Hard disk	300MB or more available space (including sample image files and help files)
Monitor	SVGA resolution or better and capable of displaying more than 256 colours (True Color recommended)
Supported OS	Windows® 98 Second Edition, Windows® Me, Windows® 2000 Professional, Windows® XP Professional, Windows® XP Home Edition, Windows Vista™*
Network protocols	TCP/IP (using Network Scanner Tool)

* Available at a later date

SPECIFICATIONS (tentative)

General	
Type	Console
Engine speed*1	Max. 55 cpm/ppm
Paper size	Max. A3 (11" x 17"), min. A5R (5 1/2" x 8 1/2R")
Paper capacity (80 g/m ²)	Standard: 3,100 sheets (1,200-sheet tray, 800-sheet tray, two 500-sheet trays, and 100-sheet multi-bypass tray) Maximum: 6,600 sheets
Warm-up time	Less than 120 sec.*2
Memory	Standard: 128MB Maximum: 384MB 40GB HDD*3
Power requirements	Rated local AC voltage ±10%, 50/60 Hz
Power consumption (max.)	1.84 kW (220 to 240V), 1.80 kW (100 to 127V)
Dimensions (W x D x H)	728 x 679 x 1,192 mm (28 2 1/32" x 26 47/64" x 46 15/16")
Weight	Approx. 185 kg (407.3 lbs.)
Features	Card shot, edge/centre erase, job build, pre-heat/auto power shut-off modes, user control (500 accounts), toner save mode, document filing

Copier	
Original paper size	Max. A3 (11" x 17")
First copy time*4	4.0 sec.
Continuous copy	Max. 999 copies
Resolution	Scan: 600 x 600 dpi, 600 x 300 dpi, 600 x 367 dpi (using DSPF) Print: 600 x 600 dpi
Gradation	Scan: 256 levels Print: 2 levels
Zoom range	25 to 400% (25 to 200% using DSPF) in 1% increments
Preset copy ratios	Metric: 10 ratios (5R/5E), inch: 8 ratios (4R/4E)
Features*5	Auto paper selection (mixed size feeding), paper type selection, auto magnification selection, auto tray switching, rotation copy, electronic sorting, network tandem copy, book copy, margin shift, dual page copy, multi-shot (4-in-1, 2-in-1), cover/transparency/tab page insertion, pamphlet copy, rotation sort*6, XY zoom, mirror image, 2-sided copy orientation change, B/W reverse*7, duplex copy, reserved copy, job programme, irregular original/paper size input, stamps (date, page number, text, stamp), tab copy

Network Scanner (optional MX-NSX1 [and MX-NBX1 for MX-M550U] required)	
Compatibility	TWAIN compliant (push out method)
Resolution	200, 300, 400, 600 dpi
File formats	TIFF, TIFF-F, TIFF-FX, PDF, linearised PDF
Scanner utilities	Sharpdesk
Scan destinations	Scan to e-mail, desktop, FTP server, network folder (SMB), HDD
Features	Internet fax*8, PC-Internet fax transmission*8, LDAP support, direct entry (address, subject, message), 999 one-touch dials, 500 group dials, 8 job programmes, broadcasting, long original scanning (max. 800 mm)

* 1 : Copy mode: When copying same document continuously on portrait A4 (8 1/2" x 11") plain paper in non-offset mode. Print mode: When printing same document continuously on portrait A4 (8 1/2" x 11") plain paper in non-offset mode, excluding processing time.
 * 2 : At rated voltage, 25°C (73.4°F), 65% RH.
 * 3 : HDD capacity depends on procurement and sourcing status.
 * 4 : Portrait feeding of A4 (8 1/2" x 11") sheets from main unit's 1st paper tray, using document glass in Auto Exposure mode with polygon motor running.
 * 5 : Some features require option(s). * 6 : Not available when equipped with a finisher.
 * 7 : Not available in some regions. * 8 : Optional MX-FWX1 required. Max. resolution 400 dpi.
 * 9 : Measured using Sharp's standard chart (A4 with 6% coverage). The Quick File Folder shares the HDD with the Job Build function. * 10 : Optional AR-FX8 required.
 * 11 : Optional MX-PKX1 required for Mac OS and EtherTalk. Windows Vista and IPsec available at a later date.
 * 12 : Optional MX-PKX1 required. * 13 : Some features are not available according to the printer driver used.
 * 14 : Based on Sharp's standard chart with approx. 700 characters (A4 or 8 1/2" x 11" portrait) at standard resolution in Super G3 mode, 33,600 bps, JBIG compression. * 15 : For Windows environments only.

• Design and specifications are subject to change without prior notice.
 • Windows, Windows Server and Windows Vista are either registered trademarks or trademarks of Microsoft Corporation in the United States and/or other countries. All other brand names and product names may be trademarks or registered trademarks of their respective owners.
 • The Energy Star logo is a certification mark and may only be used to certify products that have been determined to meet the Energy Star programme requirements. Energy Star is a US registered mark. The Energy Star guidelines apply to products only in the US, Europe, Australia, New Zealand and Japan.

Document Filing	
Document filing capacity	16GB Main and custom folders: 20,000 pages*9 or 3,000 files Quick file folder: 10,000 pages*9 or 1,000 files
Stored jobs	Copy, print, scan, fax transmission*10
Storage folders	Quick file folder, main folder, custom folder (max. 500 folders)
Confidential storage	Password protection

Network Printer (optional MX-NBX1 required for MX-M550U)	
Resolution	600 x 600 dpi
Enhanced resolution	1,200 x 600 dpi equivalent with smoothing
Interface	USB 2.0, 10Base-T/100Base-TX
Supported OS*11	Windows NT® 4.0 SP5 or later, Windows Server® 2003, Windows® 98/Me/2000/XP, Windows Vista™, Mac OS 9.0 to 9.2.2, Mac OS X 10.1.5, 10.2.8, 10.3.3 to 10.3.9, 10.4, 10.4.4, 10.4.7
Network protocols*11	TCP/IP (IPv4, IPv6), IPX/SPX (NetWare), NetBEUI, EtherTalk (AppleTalk)
Printing protocols	LPR, Raw TCP (port 9100), POP3 (e-mail printing), HTTP, Novell Printserver application with NDS and Bindery, FTP for downloading print files, EtherTalk printing, IPP
PDL emulation	Standard: PCL 6/5e Option*12: PS3 emulation
Available fonts	80 fonts for PCL, 136 fonts for PS3 emulation*12
Features*5 *13	Network tandem print, RIP Once/Print Many, direct PDF/TIFF printing, job retention (print hold, proof print, confidential print), duplex print, carbon copy print, font download, pamphlet style, binding edge, printer administration utility and status monitor, N-up (2/4/6/8), IP/MAC address filtering, form overlay, paper/output tray selection, cover/chapter insertion, transparency interleave, offset output, fit to page, watermarks, auto configuration, tab print, negative image, mirror image, zoom, barcode font compatibility, secure network communications (SSL and IPsec [LPD])

Facsimile (optional AR-FX8 required)	
Compression method	MH/MR/MMR/JBIG
Communication protocol	Super G3/G3
Transmission time	Less than 3 seconds*14
Modem speed	33,600 bps to 2,400 bps with automatic fallback
Transmission resolution	From Standard (203.2 x 97.8 dpi) to Super Fine (406.4 x 391 dpi)
Recording width	A3 to A5 (11" x 17" to 5 1/2" x 8 1/2")
Memory	Standard 2MB, expandable to 10MB
Grey scale levels	Equivalent to 256 levels
Features	Duplex transmission/reception, quick on-line transmission, error correction mode, 999 one-touch dials, 500 group dials, LDAP support, 8 job programmes, broadcasting number registration, F-Code compatibility (confidential, relay broadcast), polling, memory transmission/reception, auto reduction (transmission/reception), rotation transmission/reception, print actual size, 2-in-1 transmission, long original transmission (max. 800 mm), PC-Fax transmission*15, timer transmission, paperless faxing with inbound routing to e-mail, activity report, anti-junk fax, dual page scan

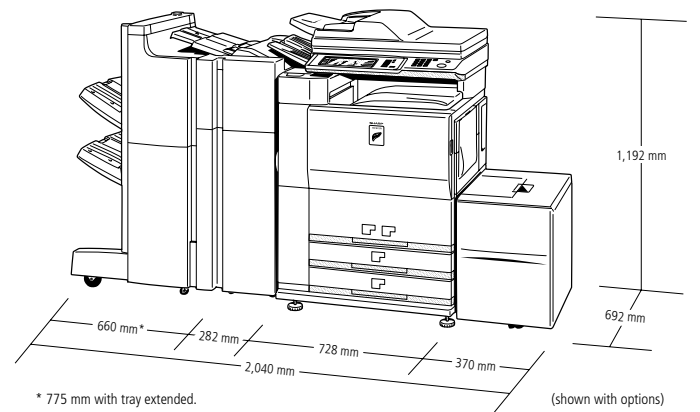

Distributed by:

SHARP

PRINTED WITH SOY INK
Printed with VOC (volatile organic compound)-free ink